

PISTON APPLICATION (Cont.)							
HP/Model	Years	PISTON			RINGS		
		Std.	.25mm	.50mm	Std.	.25mm	.50mm
P40	1998	—	—	18-4143	18-3960	18-3961	—
E48	1997	18-4097	18-4098	18-4099	18-3969	18-3970	—
50	1986-88	18-4141	18-4142	18-4143	18-3960	18-3961	—
50	1996-97, 1999, 2000, 2002-03	18-4141	18-4142	18-4143	18-3960	18-3961	—
C50	1998-99, 2001	—	18-4142	18-4143	18-3960	18-3961	—
P50	1996	—	18-4142	18-4143	18-3960	18-3961	—
P50	1987-88	18-4141	18-4142	18-4143	18-3960	18-3961	—
55	1993-95	18-4097	—	18-4099	18-3969	18-3970	—
60	1984-98	18-4091	—	18-4093	18-3963	—	—
60	2002-03	18-4091	—	18-4093	18-3963	—	—
C60	1996-01	18-4091	—	18-4093	18-3963	—	—
E60 MLH,T,U,V	1995-97	18-4094	—	18-4096	18-3963	—	—
P60	1991-99	18-4091	—	18-4093	18-3963	—	—
70	1984-98	18-4091	—	18-4093	18-3963	—	—
70	1999-03	18-4091	—	18-4093	18-3963	—	—
C70	2000-01	18-4091	—	18-4093	18-3963	—	—
75	1994-98	18-4097	18-4098	18-4099	18-3969	—	—
C75	1996	18-4097	18-4098	18-4099	18-3969	—	—
C75	1998-99	18-4097	18-4098	18-4099	18-3969	—	—
E75	1996	18-4097	18-4098	18-4099	18-3969	—	—
E75	1997	18-4097	18-4098	18-4099	18-3969	—	—
P75	1996-99	18-4097	18-4098	18-4099	18-3969	—	—
C80	1997	18-4097	18-4098	18-4099	18-3969	—	—
C85	1992-96	18-4097	18-4098	18-4099	18-3969	—	—
90	1994-99	18-4097	18-4098	18-4099	18-3969	—	—
C90	1997-01	18-4097	18-4098	18-4099	18-3969	—	—

V4 & V-6 Engines	Years	Port Std.	Stbd. Std.	Port .25mm	Stbd. .25mm	Port .50mm	Stbd. .50mm	Std.	
115 w/22mm wrist pin	V-4	1984-86	18-4128	18-4129	18-4130	18-4131	18-4132	18-4133	18-3934
115 w/22mm wrist pin	V-4	1987-92	18-4128	18-4129	18-4130	18-4131	18-4132	18-4133	18-3934
115 w/23mm wrist pin	V-4	1993-03	18-4080	18-4081	18-4082	18-4083	18-4084	18-4085	18-3934
130 w/22mm wrist pin	V-4	1984-92	18-4128	18-4129	18-4130	18-4131	18-4132	18-4133	18-3934
130 w/23mm wrist pin	V-4	1993-03	18-4080	18-4081	18-4082	18-4083	18-4084	18-4085	18-3934
150, 175 w/22mm wrist pin	V-6	1984-92	18-4128	18-4129	18-4130	18-4131	18-4132	18-4133	18-3934
150, 175 w/23mm wrist pin	V-6	1993-99	18-4080	18-4081	18-4082	18-4083	18-4084	18-4085	18-3934
200, 225 w/22mm wrist pin	V-6	1984-92	18-4128	18-4129	18-4130	18-4131	18-4132	18-4133	18-3934
200, 225 w/22mm wrist pin	V-6	1993-99	18-4080	18-4081	18-4082	18-4083	18-4084	18-4085	18-3934
V6 SPECIAL J,K,L,N,XN (6G7)V-6		1984-86	18-4128	18-4129	18-4130	18-4131	18-4132	18-4133	18-3934

 <p><b>18-4157</b> <b>CONNECTING ROD</b> Replaces: 6R5-11650-10-00 For: V6 150/175/200</p>	 <p><b>18-4158</b> <b>CONNECTING ROD</b> Replaces: 6E5-11650-01-00 For: V4 115/140</p>	 <p><b>18-4077</b> <b>ROD BEARING</b> Replaces: 93310-730V8 For: 45, 55, 90 HP -3 Cyl.</p>
 <p><b>18-4078</b> <b>ROD BEARING</b> Replaces: 93310-836V2 For: V4 &amp; V6 (1990 motors)</p>	 <p><b>18-2773</b> <b>BEARING CARRIER</b> Replaces: 663-45331-00-94 For: E48 (1995, 1997-00) / C55 (1991-95)</p>	 <p><b>18-2782</b> <b>BEARING CARRIER</b> Replaces: 688-45331-00-94 For: F40 (1999) F50/T50 (1996-00) 60 (2002-03) C60 (1998-01) E60 (1995-99) P60 (1991-99) 70 (1984-03) C70 (2000-01) C75 (1994-96 / 1998-99) E75 (1995-00) P75 (1996-99) C80 (1997) C85 (1991-96)</p>

**Features...**

- ★ Manufactured to meet or exceed OEM specifications.
- ★ Made by a leading OEM supplier.
- ★ Field-tested and approved.



**OIL FILTERS**

Sierra #	AP #	Replaces:
<b>18-7824</b>	<b>6003/6006</b>	For: All V-8 5.0L, 5.7L - Spin On Lube
<b>18-7876</b>	<b>6005</b>	For: All V-8 5.0L, 5.7L - Spin On Lube
<b>18-7875</b>	<b>6007</b>	For: All V-6 4.3L
<b>18-7901</b>	—	6G8-13440-00-00 For: F&T 9.9 (1990-99)
<b>18-7902</b>	<b>13528</b>	3FV-13440-00-00 For: F15 (1998-99), F40 (1999), F25 (1998-99), F&T50 (1995-98), F80 (1999), F100 (1999)
<b>18-7906</b>	<b>F200/F225</b>	69J-13440-00-00
<b>18-7911</b>	—	5GH-13440-00-00 For: F15 (2000-03), F&T 25 (2000-03), F40 (2001-03), F&T 50 (2000-03), F60, F80, F100 (2000-03), F115

**OUTBOARD**



**Features...**

- ★ Stainless steel fire rings on the head gasket.
- ★ Silicone beading on critical, hard to seal surfaces.
- ★ Gasket materials are engineered with specific sealing properties to provide maximum sealing and performance.

**OUTBOARD**



**18-4400**  
**AP# 13313**  
**POWERHEAD GASKET SET**  
Replaces: 61A-W0001-01-00, 61A-W0001-A1-00  
— CONTAINS—

Sierra #	Desc.	O.E. #	Qty.
18-3891	Head Gasket	61A-11181-00-A0	2
18-7443	O-Ring	93210-81MA6-00	1
18-7439	O-Ring	93210-54M54-00	2
18-7438	O-Ring	93210-50MA8-00	6

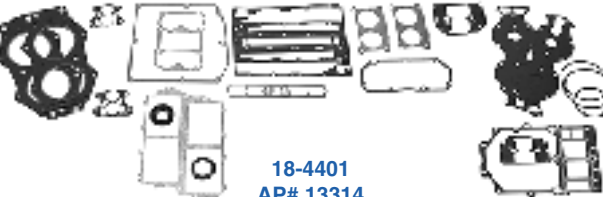

**18-4401**  
**AP# 13314**  
**POWERHEAD GASKET SET**  
Replaces: 6E5-W0001-00-00, 6E5-W0001-40-00, 6E5-W0001-E0-00  
— CONTAINS—

Sierra #	AP#	Desc.	O.E. #	Qty.
18-3832	13234	Head Gasket	6E5-11181-02-00	2
18-0844	2247	Thermostat Cover Gasket	688-12414-A1-00	2
18-2079	2220	Oil Seal	93101-22M15-00	1
18-2085	2221	Oil Seal	93102-35M13-00	1
18-7442	2230	O-Ring	93210-74M35-00	1
18-7444	2231	O-Ring	93211-04384-00	2

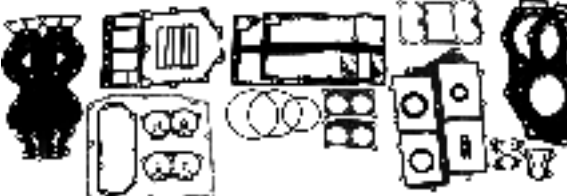

**18-4403**  
**AP#13315**  
**POWERHEAD GASKET SET**  
Replaces: 6F3-W0001-04-00, 6F3-W0001-A4-00  
— CONTAINS—

Sierra #	Desc.	O.E. #	Qty.
18-3832	Head Gasket	6E5-11181-02-00	2
18-0844	Thermostat Cover Gasket	688-12414-A1-00	2
18-2079	Oil Seal	93101-22M15-00	1
18-2085	Oil Seal	93102-35M13-00	1
18-7442	O-Ring	93210-74M35-00	1
18-7444	O-Ring	93211-04384-00	2

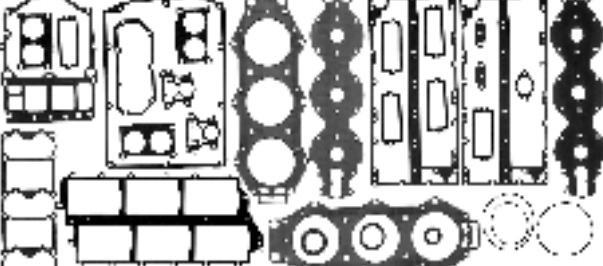

**18-4404**  
**AP# 13316**  
**POWERHEAD GASKET SET**  
Replaces: 6G5-W0001-03-00, 665-W0001-A3-00  
— CONTAINS—

Sierra #	Desc.	O.E. #	Qty.
18-3894	Head Gasket	6G5-11181-A0-00	2
18-0844	Thermostat Cover Gasket	688-12414-A1-00	2
18-2079	Oil Seal	93101-22M15-00	1
18-2085	Oil Seal	93102-35M13-00	1
18-7442	O-Ring	93210-74M35-00	1
18-7444	O-Ring	93211-04384-00	2

APPLICATIONS ON PAGE 378  
ALL PARTS SHOWN ARE INCLUDED IN KIT. PART#'S LISTED, ARE AVAILABLE INDIVIDUALLY

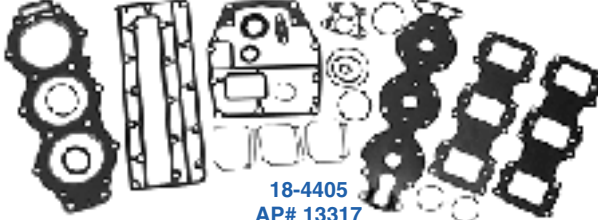

**18-4405**  
**AP# 13317**  
**POWERHEAD GASKET SET**  
Replaces: 6H1-W0001-00-00, 6H1-W0001-01-00,  
6H1-W0001-A0-00  
— CONTAINS—

Sierra #	Desc.	O.E. #	Qty.
18-3805	Head Gasket	688-11181-02-00	1
18-0840	O-Ring	676-14984-00-00	3
18-0844	Thermostat Cover Gasket	688-12414-A1-00	1
18-0845	Intake Manifold Reed Plate Gasket	688-13621-A1-00	2
18-0846	Carburetor Mounting Gasket	688-14198-A1-00	3
18-0847	Exhaust Cover Gasket	688-41112-A0-00	1
18-0826	Plug Gasket	90430-14115-00	1
18-7430	O-Ring	93210-03261-00	1
18-7434	O-Ring	93210-39ME4-00	3
18-7436	O-Ring	93210-46044-00	3
18-7441	O-Ring	93210-62269-00	1
18-0767	Water Jacket Cover Gasket	688-11193-01-00	1

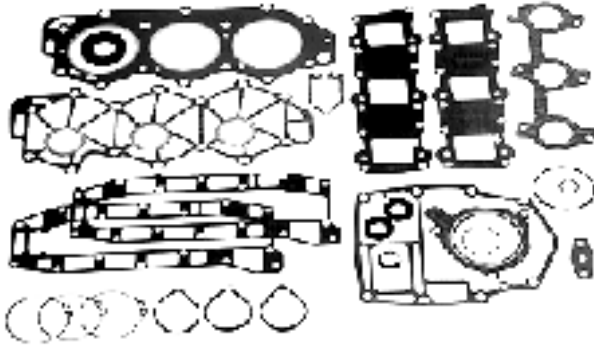

**18-4407**  
**AP# 13318**  
**POWERHEAD GASKET SET**  
Replaces: 6H4-W0001-01-00, 6H4-W0001-A1-00  
— CONTAINS—

Sierra #	Desc.	O.E. #	Qty.
18-3830	Head Gasket	6H4-11181-00-00	1
18-0826	Plug Gasket	90430-14115-00	1

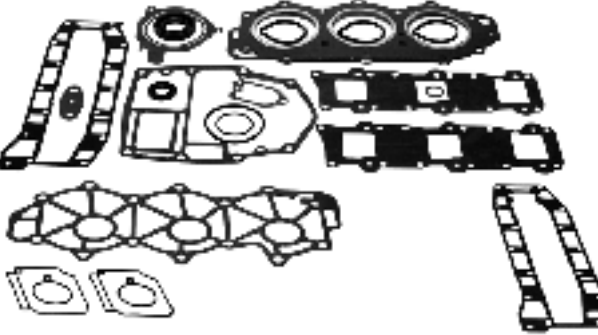

**18-4409**  
**AP# 13319**  
**POWERHEAD GASKET SET**  
Replaces: 6H4-W0001-03-00, 6H4-W0001-04-00  
— CONTAINS—

Part #	Desc.	O.E.#	Qty.
18-3830	Head Gasket	6H4-11181-00-00	1
18-0826	Plug Gasket	90430-14115-00	1
18-7432	O-Ring	93210-32768-00	1

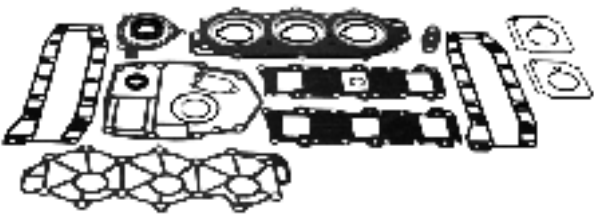

**18-4410**  
**AP# 13320**  
**POWERHEAD GASKET SET**  
Replaces: 6K7-W0001-04-00, 6K7-W0001-A4-00  
— CONTAINS—

Sierra #	Desc.	O.E. #	Qty.
18-3894	Head Gasket	6G5-11181-A0-00	2
18-0844	Thermostat Cover Gasket	688-12414-A1-00	2
18-2079	Oil Seal	93101-22M18-00	1
18-2085	Oil Seal	93102-35M13-00	1
18-7442	O-Ring	93210-74M35-00	1
18-7444	O-Ring	93211-04384-00	2

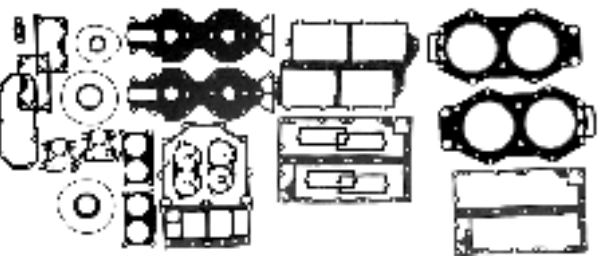

**18-4411**  
**AP# 13321**  
**POWERHEAD GASKET SET**  
Replaces: 6N6-W0001-03-00, 6N6-W0001-A3-00  
— CONTAINS—

Sierra #	Desc.	O.E. #	Qty.
18-3832	Head Gasket	6E5-11181-02-00	2
18-0844	Thermostat Cover Gasket	688-12414-A1-00	2
18-2079	Oil Seal	93101-22M18-00	1
18-2085	Oil Seal	93102-35M13-00	1
18-7442	O-Ring	93210-74M35-00	1
18-7444	O-Ring	93211-04384-00	2

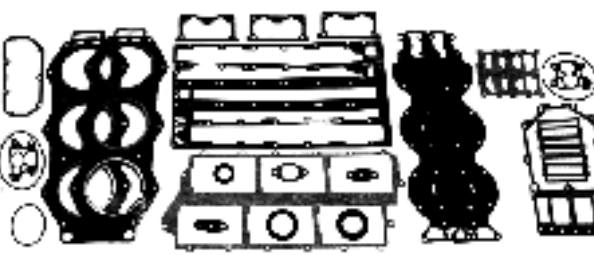

**18-4412**  
**AP# 13322**  
**POWERHEAD GASKET SET**  
Replaces: 6R3-W0001-03-00, 6R3-W0001-A3-00  
— CONTAINS—

Sierra #	Desc.	O.E. #	Qty.
18-3894	Head Gasket	6G5-11181-A0-00	2
18-0844	Thermostat Cover Gasket	688-12414-A1-00	2
18-2079	Oil Seal	93101-22M18-00	1
18-2085	Oil Seal	93102-35M13-00	1
18-7442	O-Ring	93210-74M35-00	1
18-7444	O-Ring	93211-04384-00	2

APPLICATIONS ON PAGE 378  
ALL PARTS SHOWN ARE INCLUDED IN KIT. PART#'S LISTED ARE AVAILABLE INDIVIDUALLY

**OUTBOARD**

# YAMAHA

## Gasket Sets



**OUTBOARD**

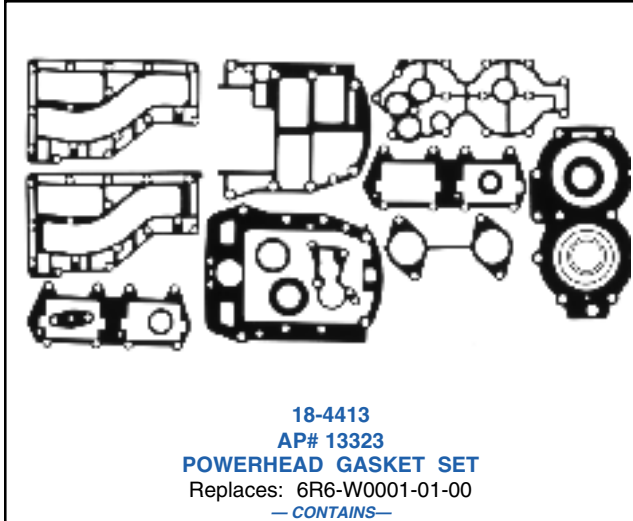

**18-4413**  
**AP# 13323**  
**POWERHEAD GASKET SET**  
 Replaces: 6R6-W0001-01-00  
 — CONTAINS —

Sierra #	Desc.	O.E. #	Qty.
18-3892	Head Gasket	676-11181-00-A0	1
18-7441	O-Ring	93210-62269-00	1

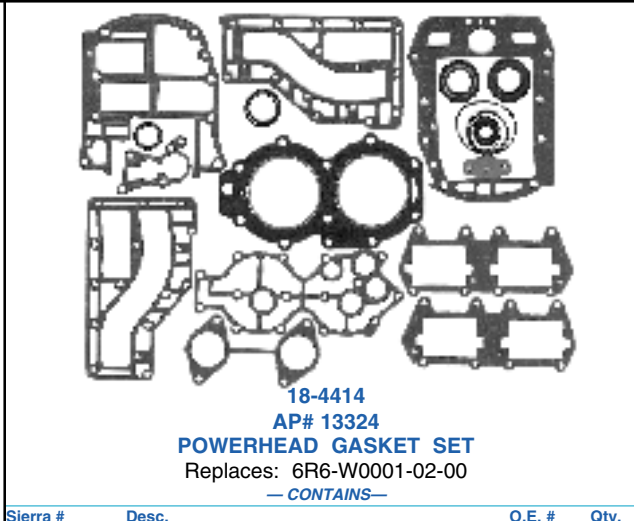

**18-4414**  
**AP# 13324**  
**POWERHEAD GASKET SET**  
 Replaces: 6R6-W0001-02-00  
 — CONTAINS —

Sierra #	Desc.	O.E. #	Qty.
18-3892	Head Gasket	676-11181-00-A0	1
18-7432	O-Ring	93210-32768-00	1
18-7441	O-Ring	93210-62269-00	1

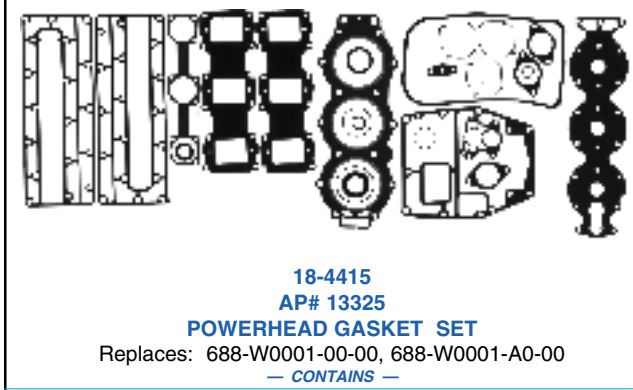

**18-4415**  
**AP# 13325**  
**POWERHEAD GASKET SET**  
 Replaces: 688-W0001-00-00, 688-W0001-A0-00  
 — CONTAINS —

Sierra #	Desc.	O.E. #	Qty.
18-0840	Fuel Bowl Seal	676-14984-00-00	3
18-3805	Head Gasket	688-11181-02-00	1
18-0844	Thermostat Cover Gasket	688-12414-A1-00	1
18-0846	Carburetor Mounting Gasket	688-14198-A1-00	3
18-0847	Exhaust Cover Gasket	688-41112-A0-00	2
18-0826	40-90 HP Plug Gasket	90430-14115-00-00	1
18-0767	Water Jacket Cover Gasket	688-11193-01-00	1
18-0845	Intake Manifold Reed Plate Gasket	688-13621-A1-00	2
18-7441	O-Ring	93210-62269-00	1

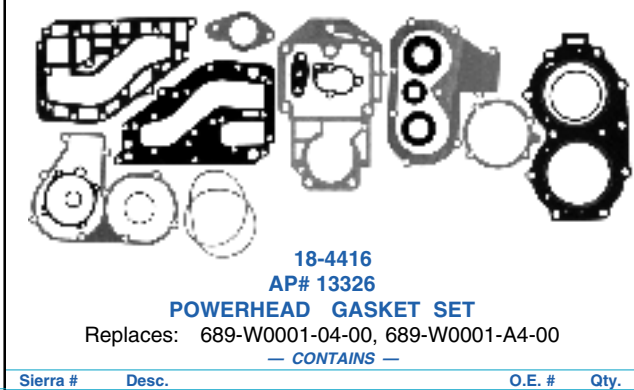

**18-4416**  
**AP# 13326**  
**POWERHEAD GASKET SET**  
 Replaces: 689-W0001-04-00, 689-W0001-A4-00  
 — CONTAINS —

Sierra #	Desc.	O.E. #	Qty.
18-0231	Packing Gasket	648-13621-A1-00	1
18-0771	Intake Manifold Gasket	648-13645-A0-00	1
18-0775	Carburetor Mounting Gasket	648-14198-A0-00	1
18-0769	Bowl Gasket	648-14384-01-00	1
18-0232	Cover Gasket	655-12414-A1-00	1
18-3804	Head Gasket	689-11181-02-00	1
18-7142	O-Ring		1
18-7397	O-Ring	93211-62M24-00-00	1
18-0752	Upper Casing Gasket	689-45113-A1-00	1
18-0253	Cover Gasket	689-41112-A0-00	1

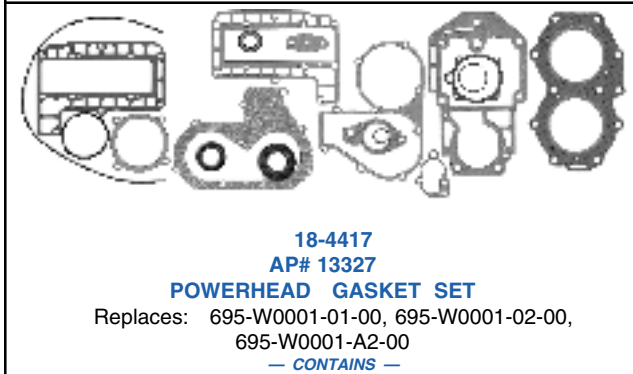

**18-4417**  
**AP# 13327**  
**POWERHEAD GASKET SET**  
 Replaces: 695-W0001-01-00, 695-W0001-02-00, 695-W0001-A2-00  
 — CONTAINS —

Sierra #	Desc.	O.E. #	Qty.
18-0231	Packing Gasket	648-13621-A1-00	1
18-0771	Intake Manifold Gasket	648-13645-A0-00	1
18-0775	Carburetor Mounting Gasket	648-14198-A0-00	1
18-0769	Bowl Gasket	648-14384-01-00	1
18-0232	Cover Gasket	655-12414-A1-00	1
18-0250	Exhaust Cover Gasket	664-41114-A0-00	2
18-2078	Oil Seal	93101-16M36-00	1
18-0570	Oil Seal	93102-23096-00	1
18-3849	Head Gasket	695-11181-A0-00	1
18-0739	Upper Casing Gasket	689-45113-A1-00	1

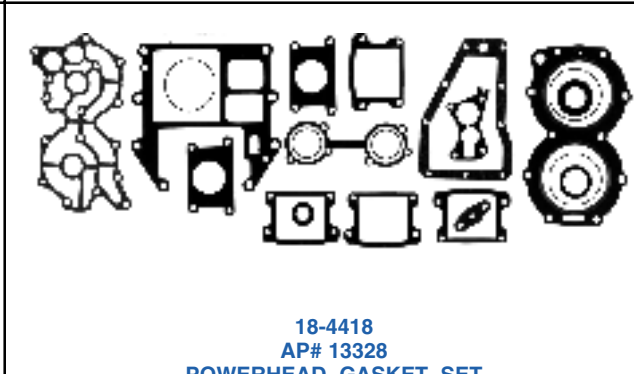

**18-4418**  
**AP# 13328**  
**POWERHEAD GASKET SET**  
 Replaces: 697-W0001-00-00, 697-E0001-A0-00  
 — CONTAINS —

Sierra #	Desc.	O.E. #	Qty.
18-0241	Valve Seat Gasket	663-13621-A0-00	2
18-0242	Valve Seat Gasket	663-13622-00-00	2
18-0245	Gasket	663-14198-A0-00	2
18-0246	Gasket	663-14483-A0-00	1
18-0247	Outer Cover Exhaust Gasket	663-41114-A0-00	1
18-3848	Head Gasket	695-11181-A0-00	1
18-7441	O-Ring	93210-62269-00-00	1

APPLICATIONS ON PAGE 378  
 ALL PARTS SHOWN ARE INCLUDED IN KIT. PART#'S LISTED ARE AVAILABLE INDIVIDUALLY

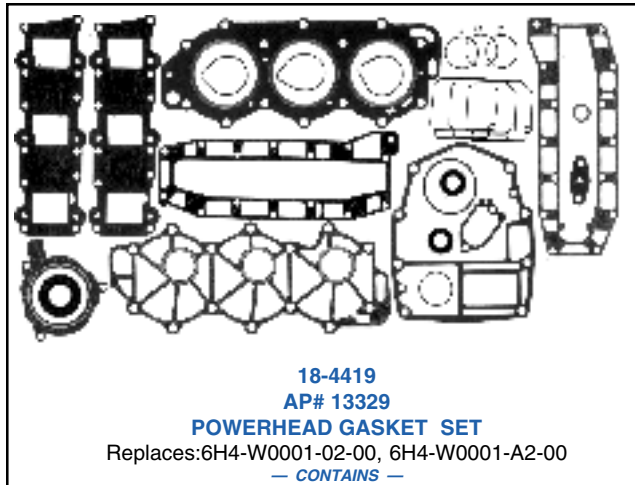

**18-4419**  
**AP# 13329**  
**POWERHEAD GASKET SET**  
Replaces: 6H4-W0001-02-00, 6H4-W0001-A2-00  
— CONTAINS —

Sierra #	Desc.	O.E. #	Qty.
18-3830	Head Gasket	6H4-11181-00-00	1
18-0826	40-90 HP Plug	90430-14115-00-00	1

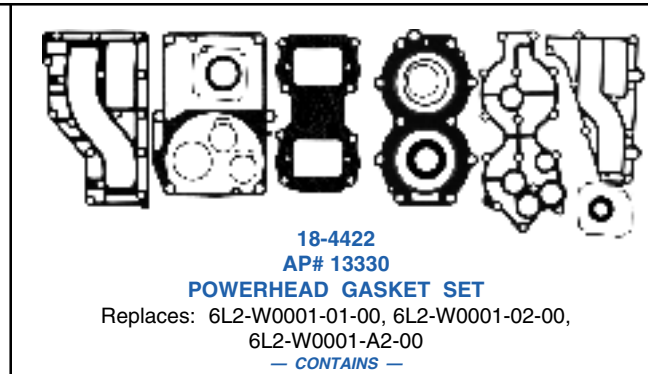

**18-4422**  
**AP# 13330**  
**POWERHEAD GASKET SET**  
Replaces: 6L2-W0001-01-00, 6L2-W0001-02-00, 6L2-W0001-A2-00  
— CONTAINS —

Sierra #	Desc.	O.E. #	Qty.
18-3847	Head Gasket	6L2-11181-A1-00	1
18-0764	Gasket	6L2-14198-00-00	1
18-0765	Flat Chamber Gasket	6L2-14384-00-00	1
18-0743	Exhaust Inner Cover Gasket	6L2-41112-A1-00	1
18-0744	Exhaust Outer Cover Gasket	6L2-41114-A1-00	1
18-0748	Upper Casing Gasket	6L2-45113-A1-00	1
18-0571	Oil Seal	93102-25142-00	1
18-7429	O-Ring	93210-56M80-00	1

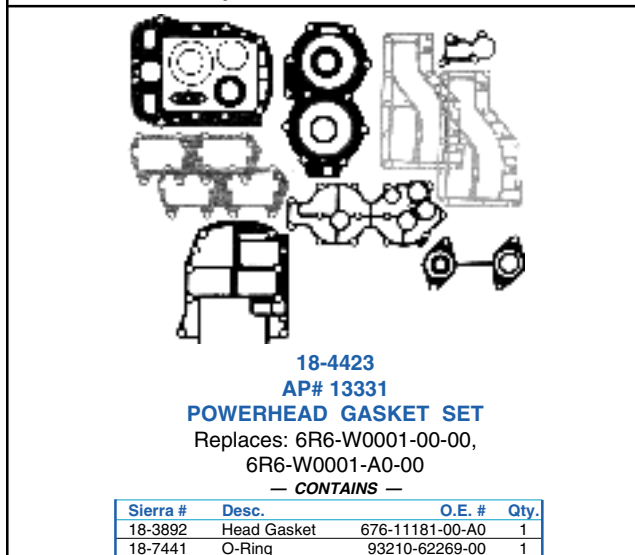

**18-4423**  
**AP# 13331**  
**POWERHEAD GASKET SET**  
Replaces: 6R6-W0001-00-00, 6R6-W0001-A0-00  
— CONTAINS —

Sierra #	Desc.	O.E. #	Qty.
18-3892	Head Gasket	676-11181-00-A0	1
18-7441	O-Ring	93210-62269-00	1

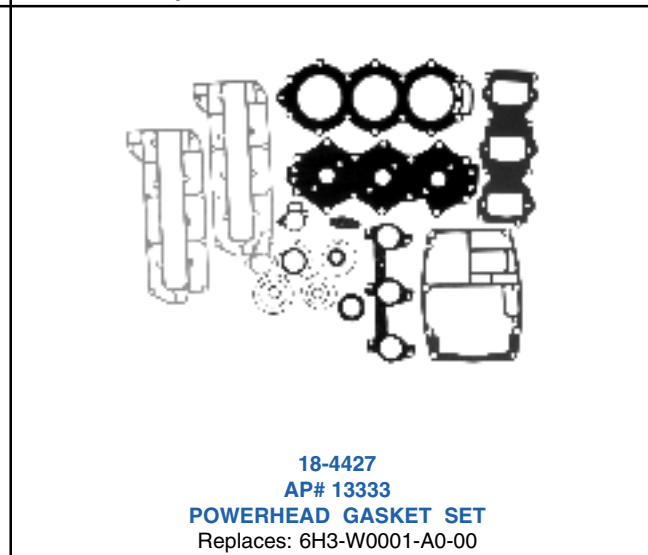

**18-4427**  
**AP# 13333**  
**POWERHEAD GASKET SET**  
Replaces: 6H3-W0001-A0-00



**18-3804**  
**AP# 13214**  
**HEAD GASKET**  
Replaces: 689-11181-02-00, 689-11181-A1-00

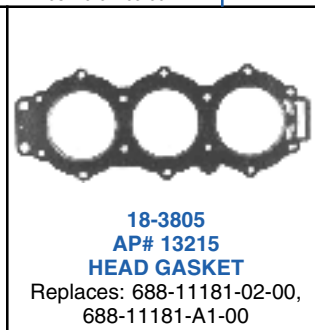

**18-3805**  
**AP# 13215**  
**HEAD GASKET**  
Replaces: 688-11181-02-00, 688-11181-A1-00

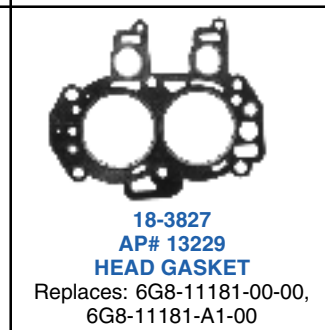

**18-3827**  
**AP# 13229**  
**HEAD GASKET**  
Replaces: 6G8-11181-00-00, 6G8-11181-A1-00

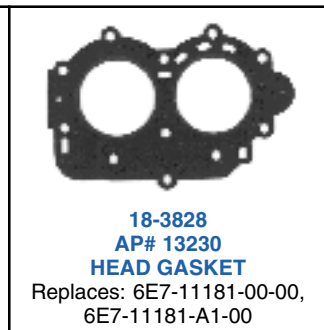

**18-3828**  
**AP# 13230**  
**HEAD GASKET**  
Replaces: 6E7-11181-00-00, 6E7-11181-A1-00

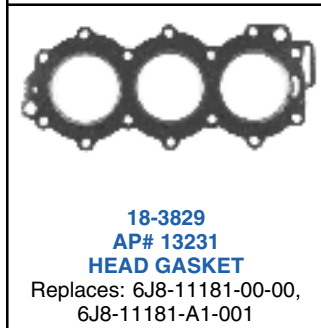

**18-3829**  
**AP# 13231**  
**HEAD GASKET**  
Replaces: 6J8-11181-00-00, 6J8-11181-A1-00

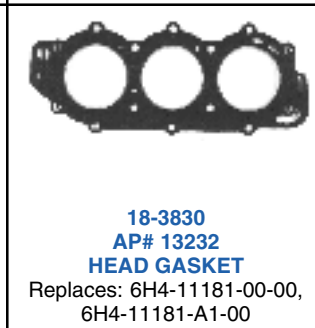

**18-3830**  
**AP# 13232**  
**HEAD GASKET**  
Replaces: 6H4-11181-00-00, 6H4-11181-A1-00

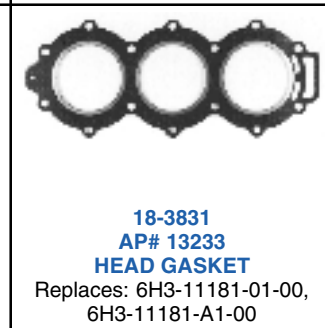

**18-3831**  
**AP# 13233**  
**HEAD GASKET**  
Replaces: 6H3-11181-01-00, 6H3-11181-A1-00

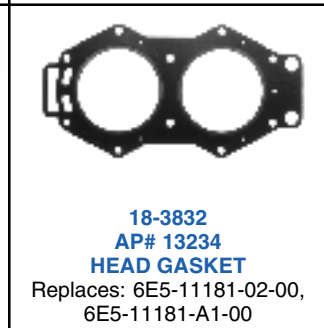

**18-3832**  
**AP# 13234**  
**HEAD GASKET**  
Replaces: 6E5-11181-02-00, 6E5-11181-A1-00

APPLICATIONS ON NEXT PAGE  
ALL PARTS SHOWN ARE INCLUDED IN KIT. PART#'S LISTED, ARE AVAILABLE INDIVIDUALLY

**OUTBOARD**

# YAMAHA

## Head Gaskets

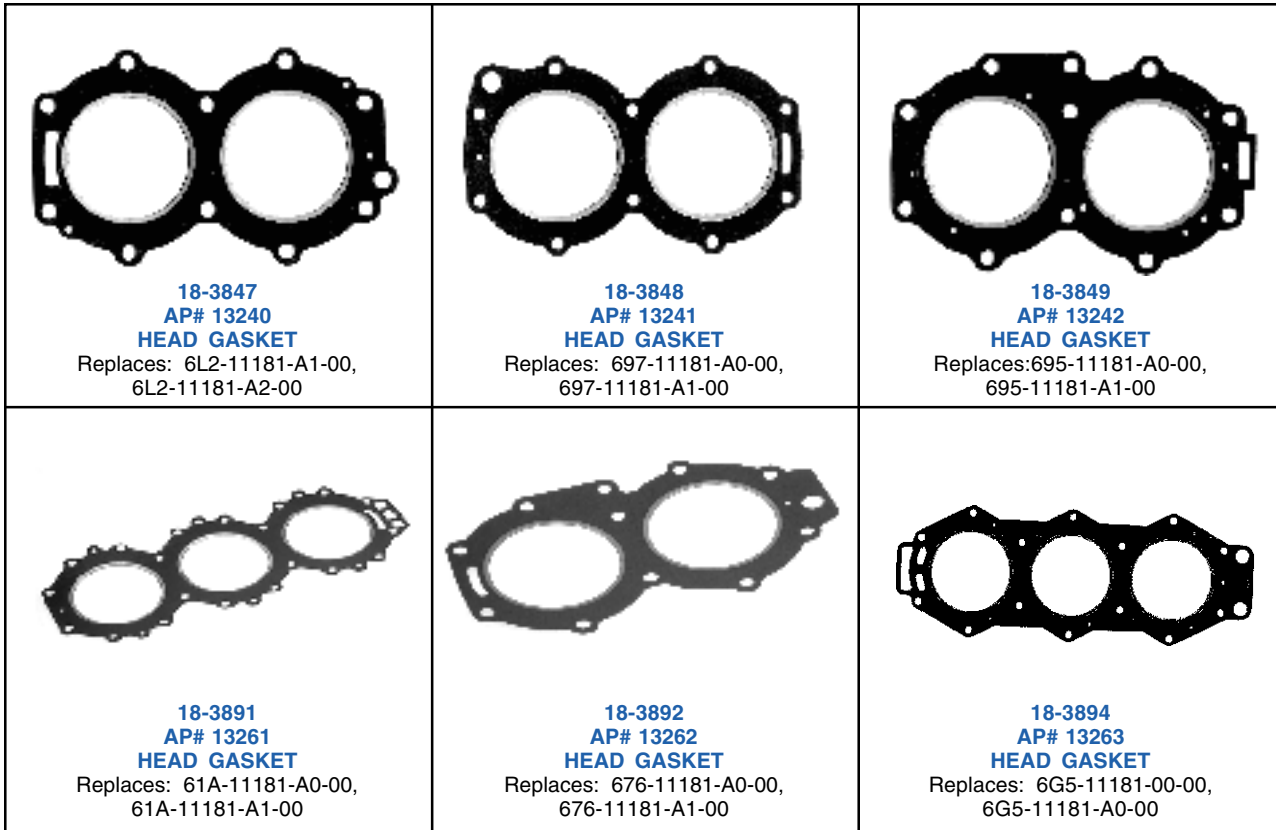

**OUTBOARD**

### POWERHEAD GASKET SETS \ HEAD GASKETS APPLICATION













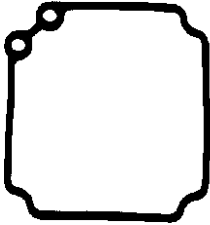

HP	Year	Powerhead Gasket Set	Head Gasket	HP	Year	Powerhead Gasket Set	Head Gasket
9.9 (4 Stroke)	1985-90	—	18-3827	CV85	1989-93	18-4415	18-3805
9.9/15	1988-93	—	18-3828	90	1984-93	18-4405	18-3805
25 two cylinder	1984-87	18-4416	18-3804	115 (6E5)	1984	18-4401	18-3832
25 two cylinder	1988-93	18-4422	18-3847	115	1986	18-4401	18-3832
C25	1990-93	18-4417	18-3849	115	1986-91	18-4403	18-3832
CV25	1990	18-4417	18-3849	115 (6E5)	1987-91	18-4403	18-3832
30	1984-86	18-4416	18-3804	115	1992-99	18-4411	18-3832
30	1987-93	—	18-3829	115 (6N6)	1992-97	18-4411	18-3832
30	1994-97	—	18-3829	C115	1991-95	18-4403	18-3832
C30	1989-92	18-4416	18-3804	P115	1993-96	18-4411	18-3832
CV30	1989	18-4416	18-3830	L130 (6L6) 130 (6L1)	1988-91	18-4403	18-3832
40	1984-88	18-4407	18-3830	L130 (6N4) 130 (6N7)		1994-99	18-4411
40	1989-91	18-4419	18-3830	18-3832			
40	1992-93	18-4409	18-3830	C150	1996-99	18-4404	18-3894
C40 two cylinder	1990-91	18-4423	18-3892	L150	1986-89	18-4404	18-3894
C40 two cylinder	1992-93	18-4413	18-3892	P150	1986-89	18-4404	18-3894
C40 two cylinder	1994-97	18-4414	18-3892	P150	1990-93	18-4412	18-3894
CV40	1990	18-4423	18-3892	P150	1994-95	18-4410	18-3894
50	1984-88	18-4407	18-3830	150/175/200 ETLN/ETXN	1984-89	18-4404	18-3894
50	1989-91	18-4419	18-3830	150, L150, P150, PRO V150D	1990-95	18-4412	18-3894
50	1992-93	18-4409	18-3830	175 (6R3)	1990-94	18-4412	18-3894
P50	1987-88	18-4407	18-3830	P175 (62H)	1994	18-4410	18-3894
P50	1989-91	18-4419	18-3830	P200 (61H)	1991-94	18-4410	18-3894
P50	1992-93	18-4409	18-3830	L200 (6R4) 200 (6R1)		1990-95	18-4412
C55	1989-91	18-4418	18-3848	18-3894			
CV55	1989	18-4418	18-3848	V6 Special (6G7)	1984-86	18-4404	18-3894
P60	1991	18-4427	18-3831	V6 Excel (6K7)	1987-89	18-4410	18-3894
70	1984-1991	18-4427	18-3831	225	1990-95	18-4410	18-3894
C85	1989-91	18-4415	18-3805	225/L225	1994-96	18-4400	18-3891
				250/L250	1990-96	18-4400	18-3891

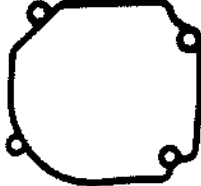
① LJ:-357803/XJ:-700843

② LJ: 357804/XJ: 700844

③ 2.6 litre engine

④ 3.1 litre engine

<p>PKG. OF 2</p>  <p><b>18-0775</b> AP# 2307 <b>CARBURETOR MOUNTING</b> Replaces: 648-14198-A0-00</p>	 <p><b>18-0785</b> AP# 2256 <b>CARBURETOR MOUNTING</b> Replaces: 6E5-14198-A1-00</p>	<p>PKG. OF 2</p>  <p><b>18-0846</b> AP# 2249 90 HP <b>CARBURETOR MOUNTING</b> Replaces: 688-14198-A1-00</p>
 <p><b>18-0765</b> <b>FLOAT CHAMBER</b> Replaces: 6L2-14384-00-00</p>	<p><b>NEW</b></p>  <p><b>18-2592</b> <b>V-4 FLOAT BOWL</b> Replaces: 6E5-14384-03-00</p>	 <p><b>18-0769</b> AP# 2308 <b>BOWL</b> Replaces: 648-14384-01-00</p>
 <p><b>18-0786</b> <b>FLOAT BOWL</b> Replaces: 6E5-14384-02-00</p>	 <p><b>18-0840</b> AP# 2029 <b>FUEL BOWL SEAL</b> Replaces: 676-14984-00-00</p>	 <p><b>18-0246</b> <b>CARBURETOR TO AIR BOX</b> Replaces: 663-14483-A0-00</p>
 <p><b>18-0789</b> AP# 2259 <b>CARBURETOR TO AIR BOX</b> Replaces: 6E5-14483-A1-00</p>	 <p><b>18-0810</b> <b>AIR CLEANER</b> Replaces: 6G5-14416-A1-00</p>	 <p><b>18-0241</b> <b>VALVE SEAT</b> Replaces: 663-13621-A0-00</p>
 <p><b>18-0242</b> <b>VALVE SEAT</b> Replaces: 663-13622-00-00</p>	<p>PKG. OF 2</p>  <p><b>18-0771</b> <b>INTAKE MANIFOLD</b> Replaces: 648-13645-A0-00</p>	 <p><b>18-0807</b> <b>REED PLATE</b> Replaces: 6K7-13645-A1-00</p>











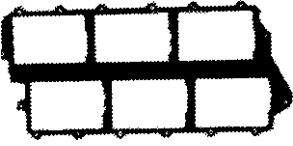

**OUTBOARD**

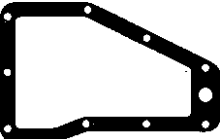
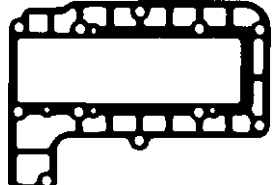
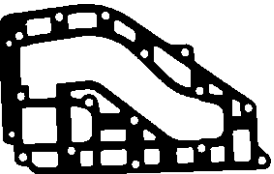
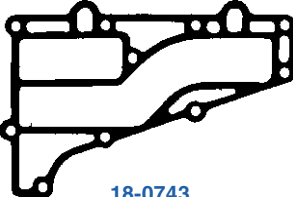

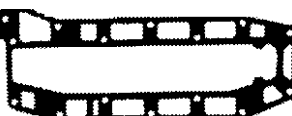
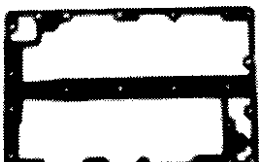
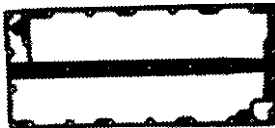
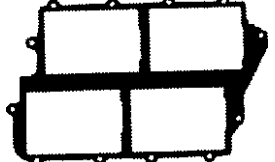
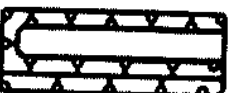
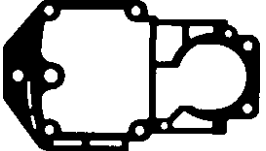
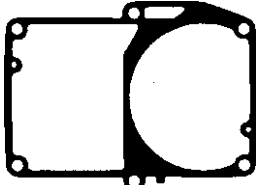
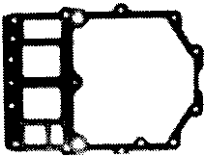
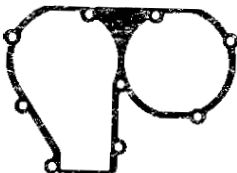







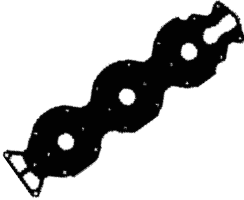

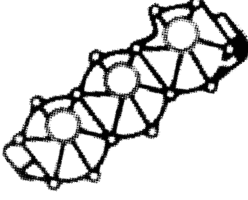

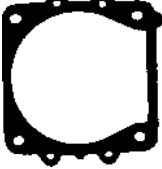

# YAMAHA

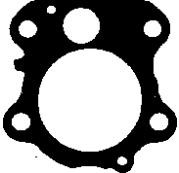
## Gaskets



OUTBOARD

 <p><b>18-0809 MANIFOLD</b> Replaces: 6G5-13645-A1-00</p>	 <p><b>18-0808 AP# 2263 VALVE COVER</b> Replaces: 6G5-11382-A1-00</p>	 <p><b>18-0816 VALVE SEAT</b> Replaces: 6H4-13621-00-00</p>	 <p><b>18-0845 90 HP INTAKE MANIFOLD/REED PLATE</b> Replaces: 688-13621-A1-00</p>
 <p><b>18-0247 EXHAUST COVER</b> Replaces: 663-41114-A0-00</p>	 <p><b>18-0250 EXHAUST COVER</b> Replaces: 664-41114-A0-00</p>	 <p><b>18-0253 COVER</b> Replaces: 689-41112-A0-00</p>	 <p><b>18-0743 INNER EXHAUST COVER</b> Replaces: 6L2-41112-A1-00</p>
 <p><b>18-0744 OUTER EXHAUST COVER</b> Replaces: 6L2-41114-A1-00</p>	 <p><b>18-0798 EXHAUST COVER</b> Replaces: 6H4-41114-A0-00</p>	 <p><b>18-0799 EXHAUST COVER</b> Replaces: 6E5-41112-A1-00</p>	 <p><b>18-0812 EXHAUST COVER</b> Replaces: 6G5-41112-A1-00</p>
 <p><b>18-0823 MANIFOLD</b> Replaces: 6E5-13645-A1-00</p>	 <p><b>18-0847 90 HP EXHAUST COVER</b> Replaces: 688-41112-A0-00</p>		 <p><b>18-0739 AP# 2319 UPPER CASING</b> Replaces: 689-45113-A1-00</p>
 <p><b>18-0748 UPPER CASING</b> Replaces: 6L2-45113-A1-00</p>	 <p><b>18-0813 AP# 2261 BASE</b> Replaces: 6G5-45113-A0-00</p>	 <p><b>18-0231 PACKING</b> Replaces: 648-13621-A1-00</p>	 <p><b>18-0232 AP# 2310 COVER</b> Replaces: 655-12414-A1-00</p>
 <p><b>18-0782 COVER</b> Replaces: 6E5-11381-A1-00</p>	 <p><b>18-0829 AP# 1740 COVER</b> Replaces: 61A-12414-A0-00</p>	 <p><b>18-0844 AP# 2247 90 HP V-4, V-6 THERMOSTAT COVER</b> Replaces: 688-12414-A1-00</p>	 <p><b>18-0767 90 HP WATER JACKET COVER</b> Replaces: 688-11193-01-00</p>

 <p><b>18-0779</b> <b>HEAD COVER</b> Replaces: 6G5-11193-A0-00</p>	 <p><b>18-0781</b> <b>HEAD COVER</b> Replaces: 6E5-11193-A0-00</p>	 <p><b>18-0815</b> <b>HEAD COVER</b> Replaces: 6H4-11193-A1-00</p>	 <p><b>18-0821</b> <b>COVER</b> Replaces: 6J8-12414-A0-00</p>	
 <p><b>18-0239</b> AP# 2020 <b>WEAR PLATE TO PUMP HOUSING</b> Replaces: 688-44315-A0-00</p>	 <p><b>18-0240</b> AP# 2022 <b>WEAR PLATE TO GEAR CASE MOUNTING</b> Replaces: 688-44315-A0-00</p>	 <p><b>18-0244</b> AP# 2052 <b>WATER PUMP</b> Replaces: 6E5-44315-A0-00</p>	 <p><b>18-0292</b> <b>WEAR PLATE TO PUMP HOUSING</b> Replaces: 663-44315-A0-00</p>	
 <p><b>18-0294</b> <b>WEAR PLATE TO PUMP BASE</b> Replaces: 663-44324-A0-00</p>	 <p><b>18-0756</b> AP# 2330 <b>WATER PUMP</b> Replaces: 6H3-44315-A0-00</p>	 <p><b>18-0757</b> AP# 2331 <b>OUTER PLATE</b> Replaces: 6H3-44324-A0-00</p>	<p>PKG. OF 2</p>  <p><b>18-0768</b> <b>WEAR PLATE</b> Replaces: 682-44315-A0-00</p>	
 <p><b>18-0773</b> AP# 2316 <b>WEAR PLATE</b> Replaces: 689-44316-A0-00</p>	 <p><b>18-0747</b> <b>WATER SEAL DAMPER</b> Replaces: 22-44367-00-00</p>	 <p><b>18-0826</b> AP# 2232 <b>40-90 HP PLUG</b> Replaces: 90430-14115-00-00</p>	 <p><b>18-0814</b> AP# 2217 <b>SEAL</b> Replaces: 6H3-14457-01-00</p>	 <p><b>18-4274</b> AP# 1831 <b>SPACER</b> Replaces: 688-45997-01-00</p>

**OUTBOARD**